

Ceiling Mount Kit 1' x 4'

Product Dimensions

P10416 MT-1x4BOX-3.0in

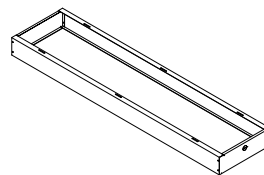

SCALE : 1:1
Measure Tolerance is: $\pm 0.15\text{ mm}$, $\pm 0.01\text{ in}$

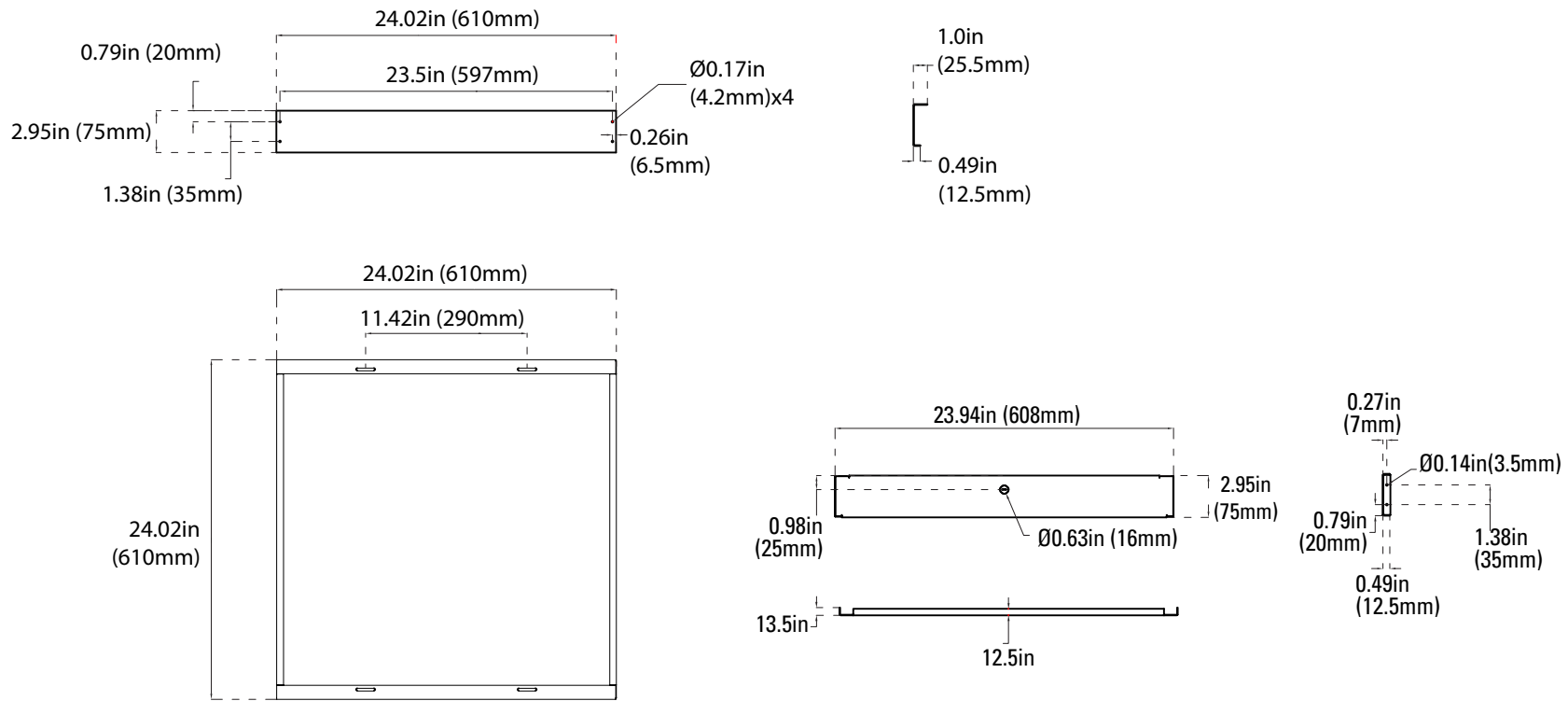

Ceiling Mount Kit 2' x 2'

Product Dimensions

P10417 MT-2x2BOX-3.0in

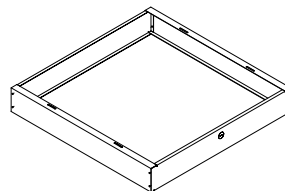

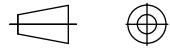

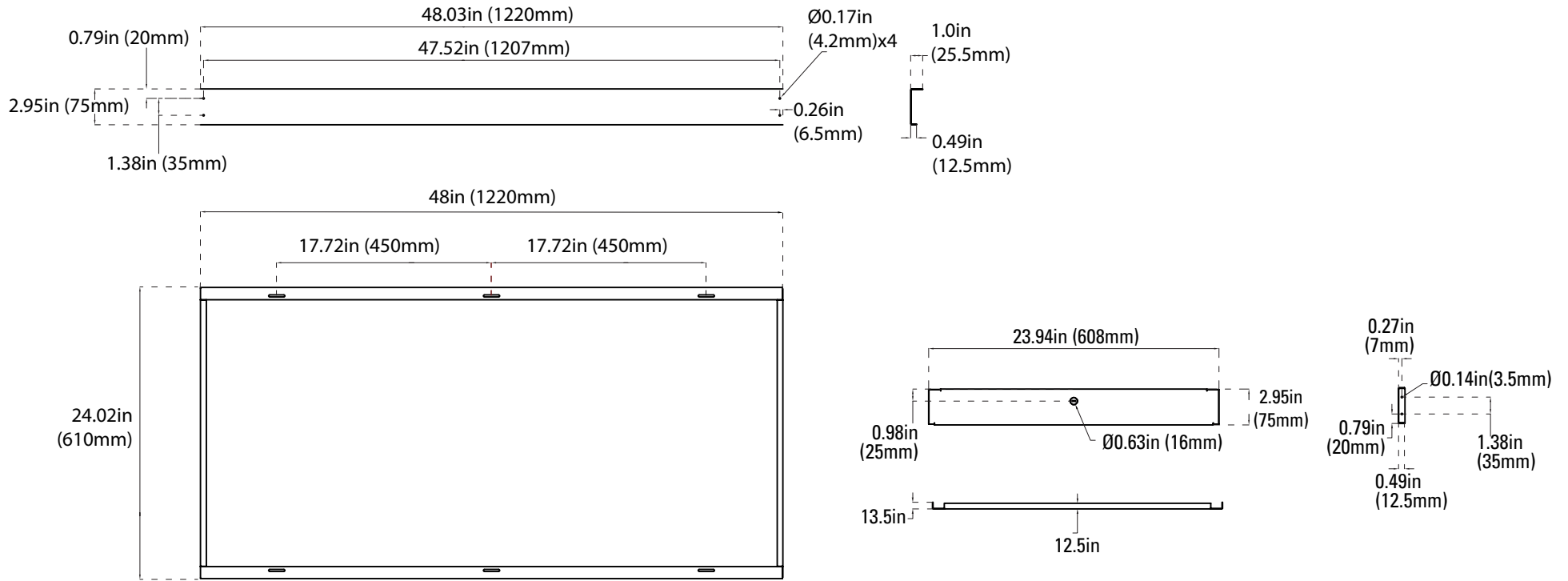
SCALE : 1:1
Measure Tolerance is: ± 0.15 mm, ± 0.01 in



Ceiling Mount Kit 2' x 4'

Product Dimensions

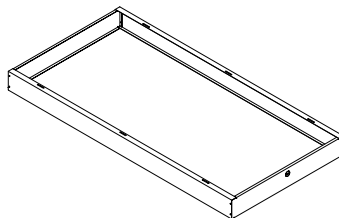
P10418 MT-2x4BOX-3.0in

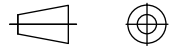

SCALE : 1:1
Measure Tolerance is: ±0.15 mm, ±0.01in